

## SAFETY INSTRUCTIONS



### WARNING:

Failure to follow these instructions may result in injury or damage to the product.

### GENERAL SAFETY

- Read all instructions carefully before installing or using the product.
- Use the product only for its intended purpose.
- Do not modify the product or use damaged components.
- Keep this product away from children unless supervised by an adult.
- You may need co-worker to assemble with safety and easily.

### INSTALLATION

- Ensure the product is installed on a stable, level surface.
- Follow the manufacturer's installation instructions exactly.
- Confirm all bolts, screws, and fasteners are securely tightened before use.
- Do not install the rack near heat sources, open flames, or electrical hazards.

### LOAD & USAGE

- Do not exceed the maximum load capacity specified for the product.
- Do not climb, sit, or stand on the product.
- Avoid sudden impacts or excessive force on the product.

### MAINTENANCE

- Inspect the product regularly for signs of wear, loosened fasteners, or damage.
- Tighten any loose components immediately
- Clean with a dry or slightly damp cloth; do not use harsh chemicals.
- Stop using the product if damage is detected until it is repaired or replaced.

### STORAGE

- Store the product in a dry location when not in use.
- Protect from excessive moisture to prevent corrosion or weakening of materials.

## EQUIPMENT FOR ASSEMBLE

Not included in the item package.

- Safety transparent glass (optional)
- Safety Gloves and Safety Shoes
- Metal Scissors
- Electrical Hand Drill



It is recommended that you have knowledge of assembly are helpful.



## K9 KENNEL STORE

1296 West 2550 South Ogden, Utah 84401  
Phone : (801) 621-4024 Fax : (801) 621-4353  
E-Mail : k9kennelsstore@gmail.com

[WWW.K9-KENNELSTORE.COM](http://WWW.K9-KENNELSTORE.COM)

**STEP 1 - ASSEMBLING INSTRUCTION**

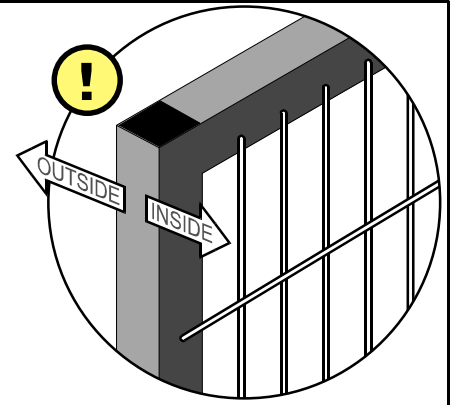
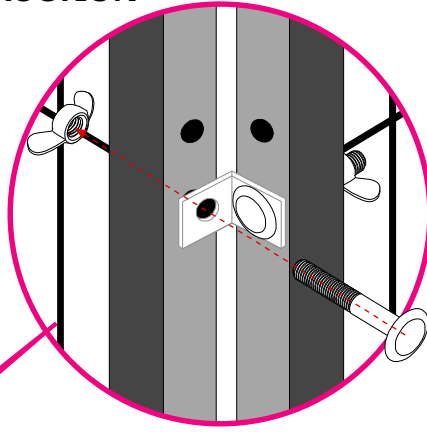
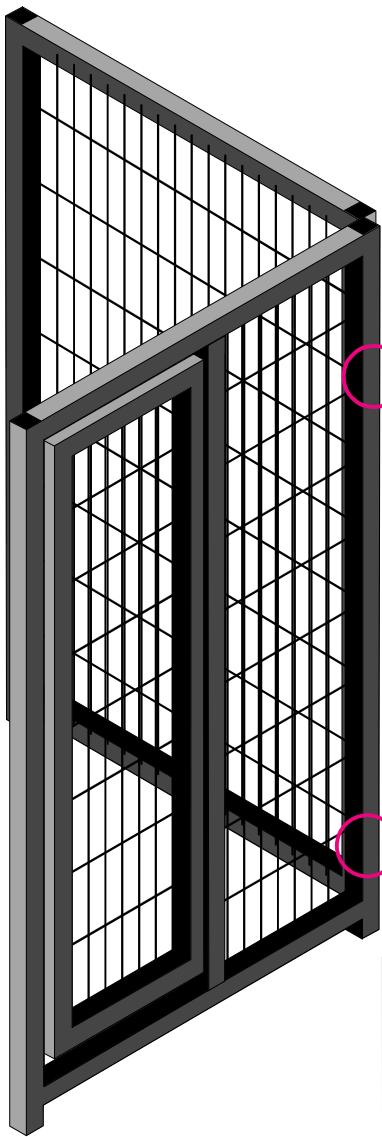

**STEP 2**

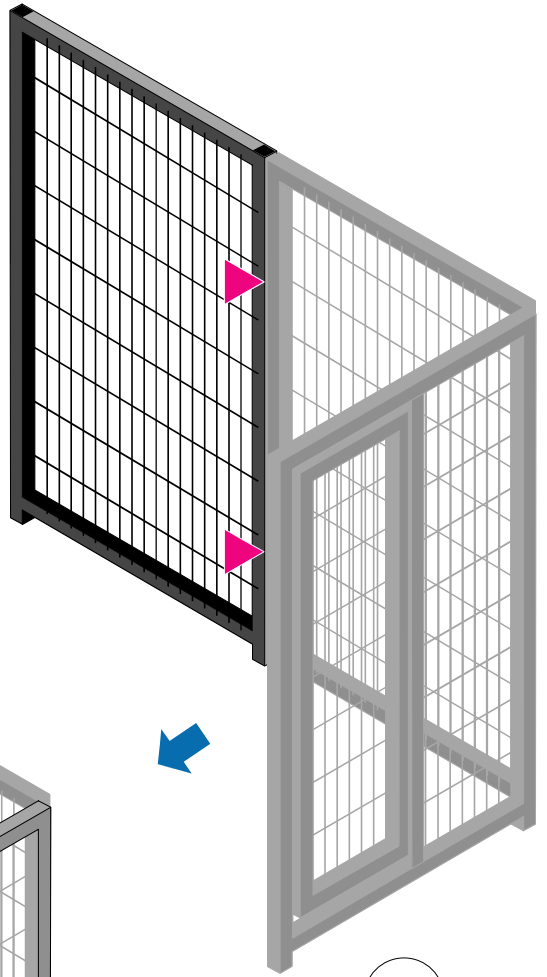
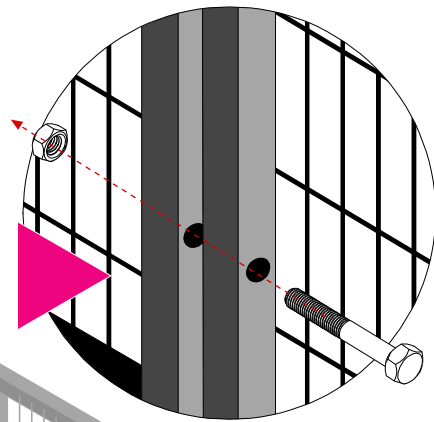

**STEP 3**

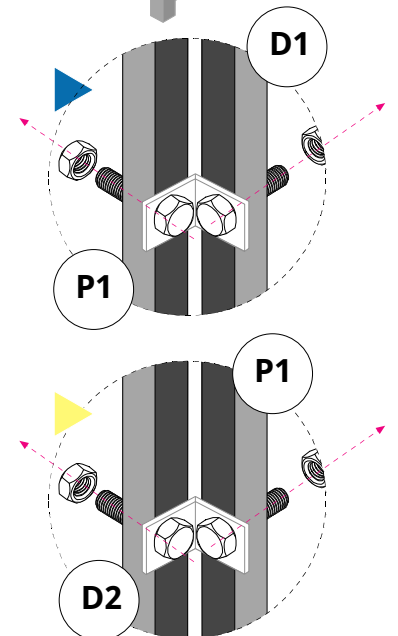
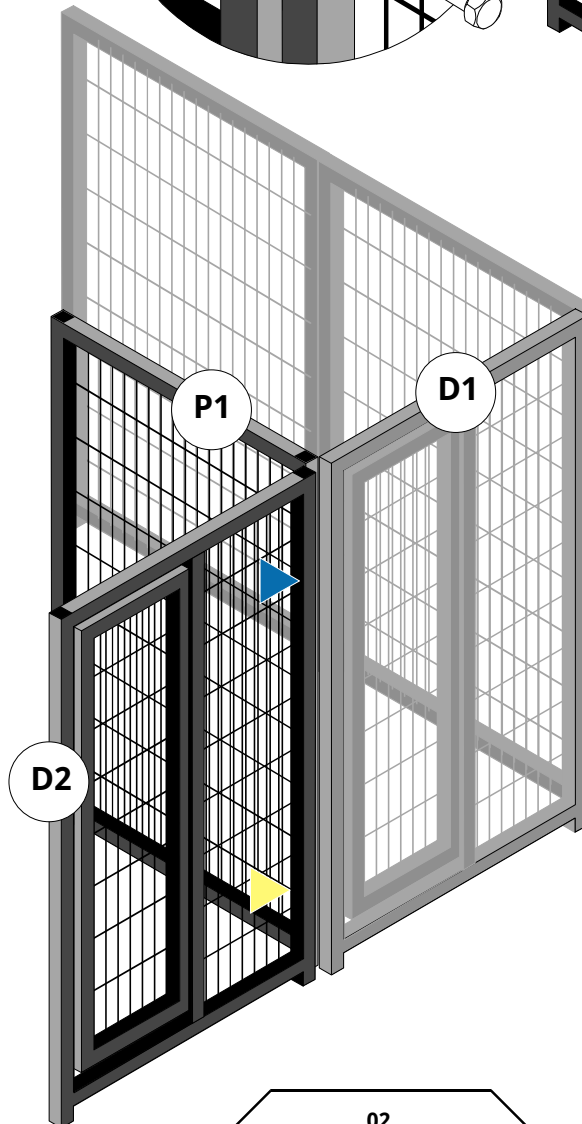

**STEP 4**

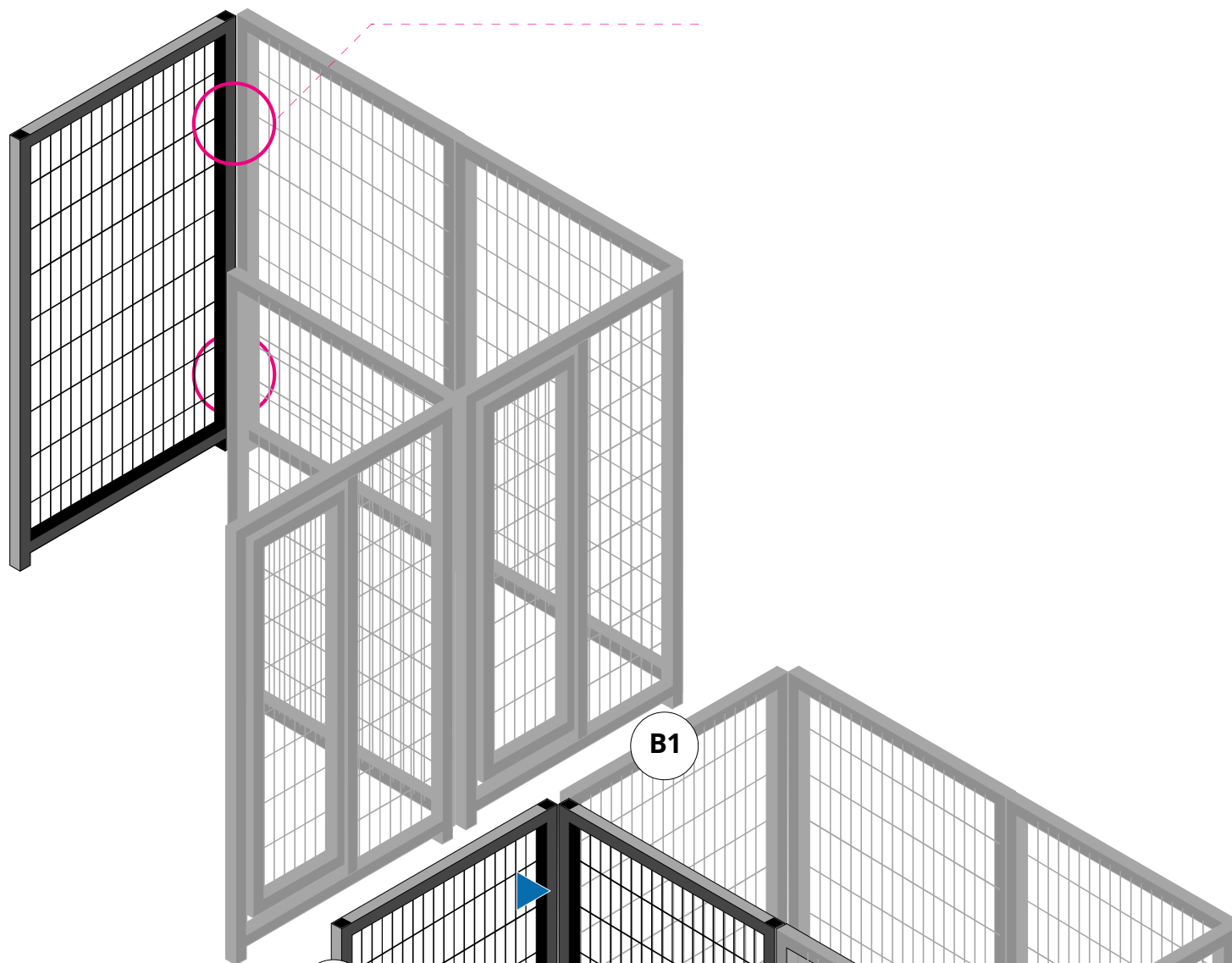

**STEP 5**

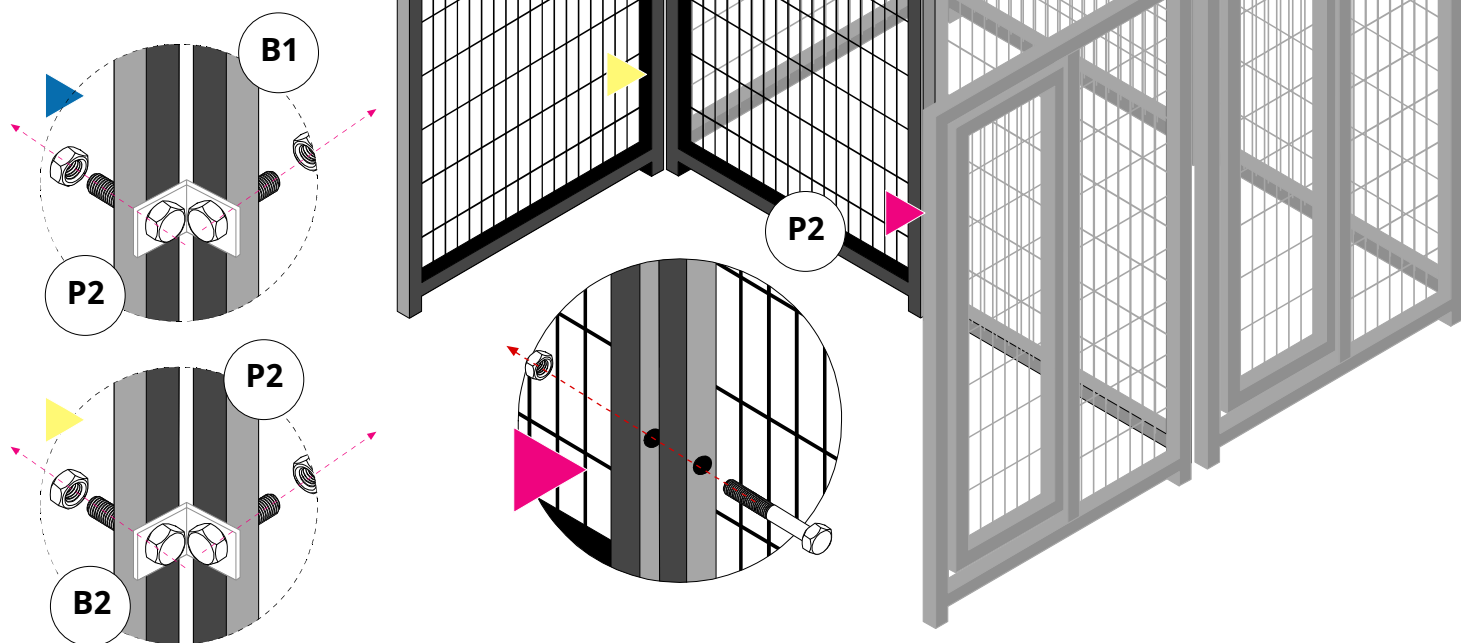

**STEP 6**

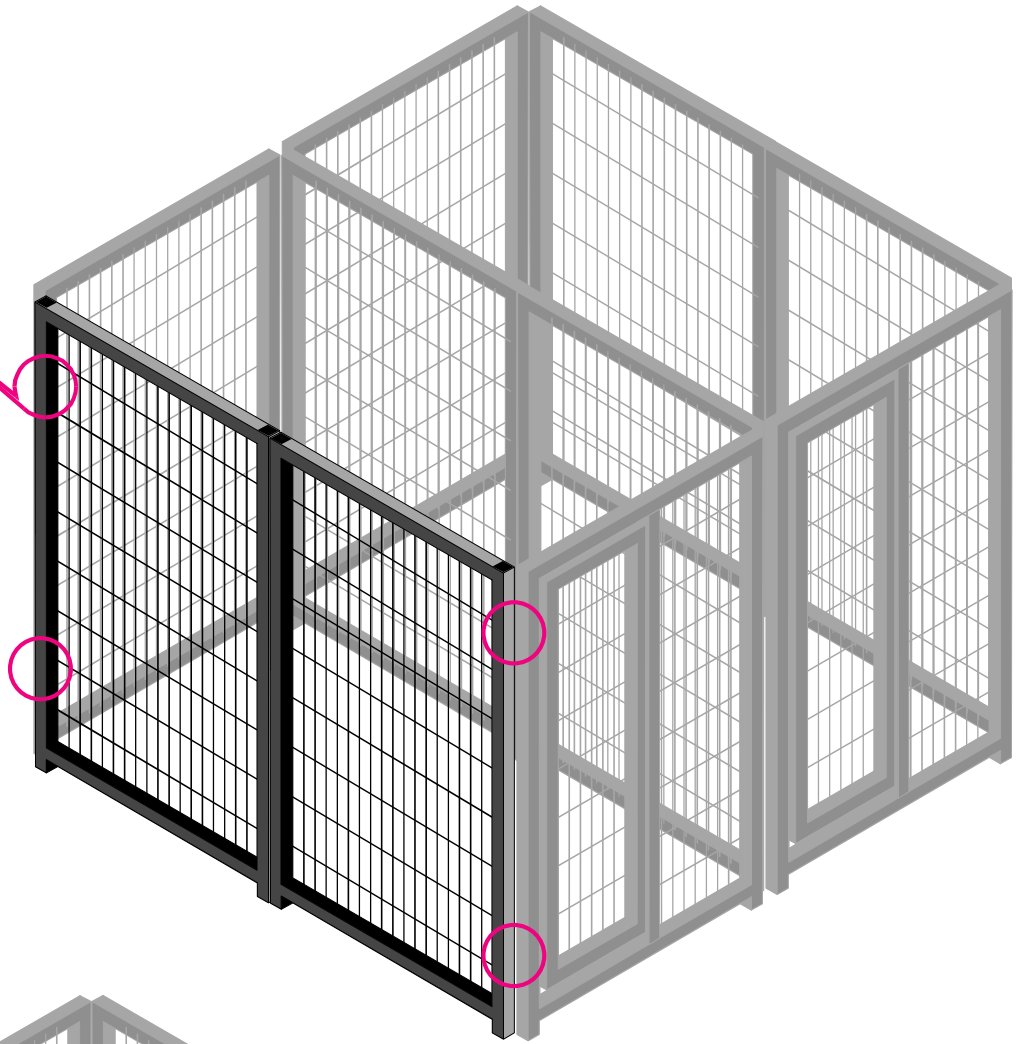
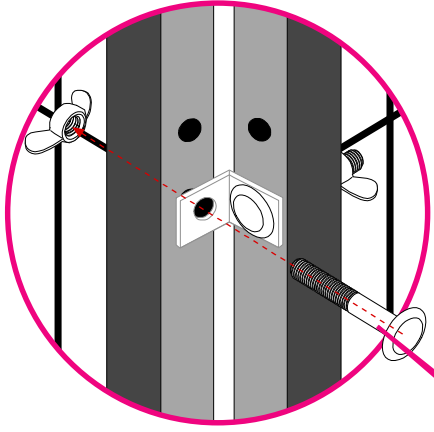

**STEP 7**

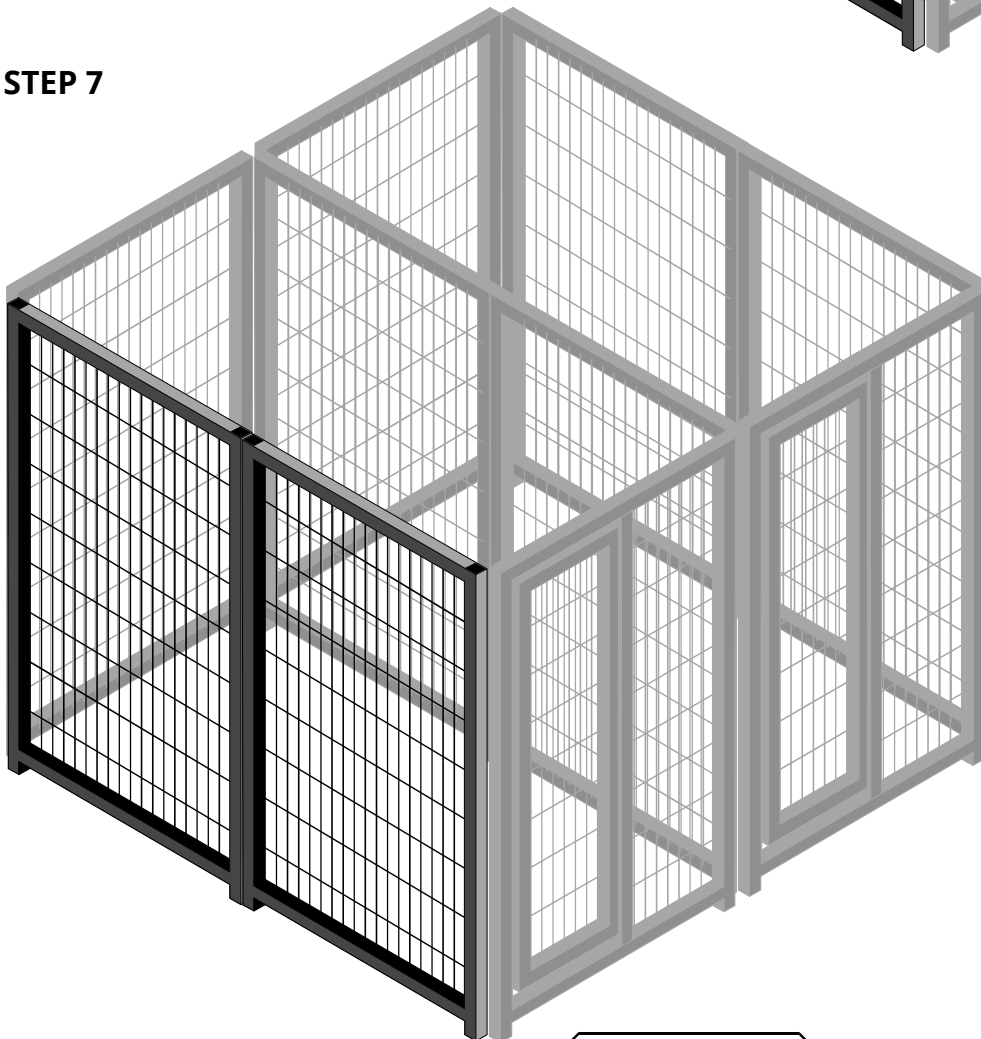

**STEP 6**

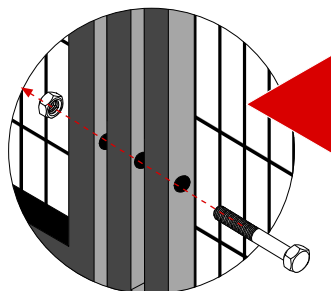
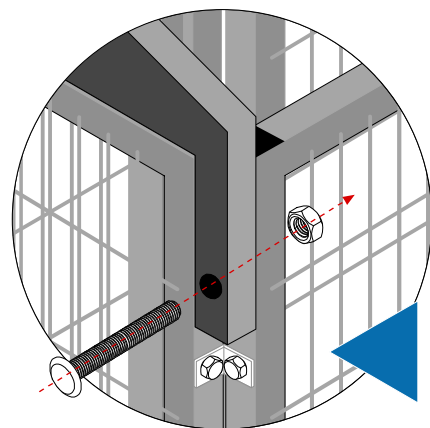
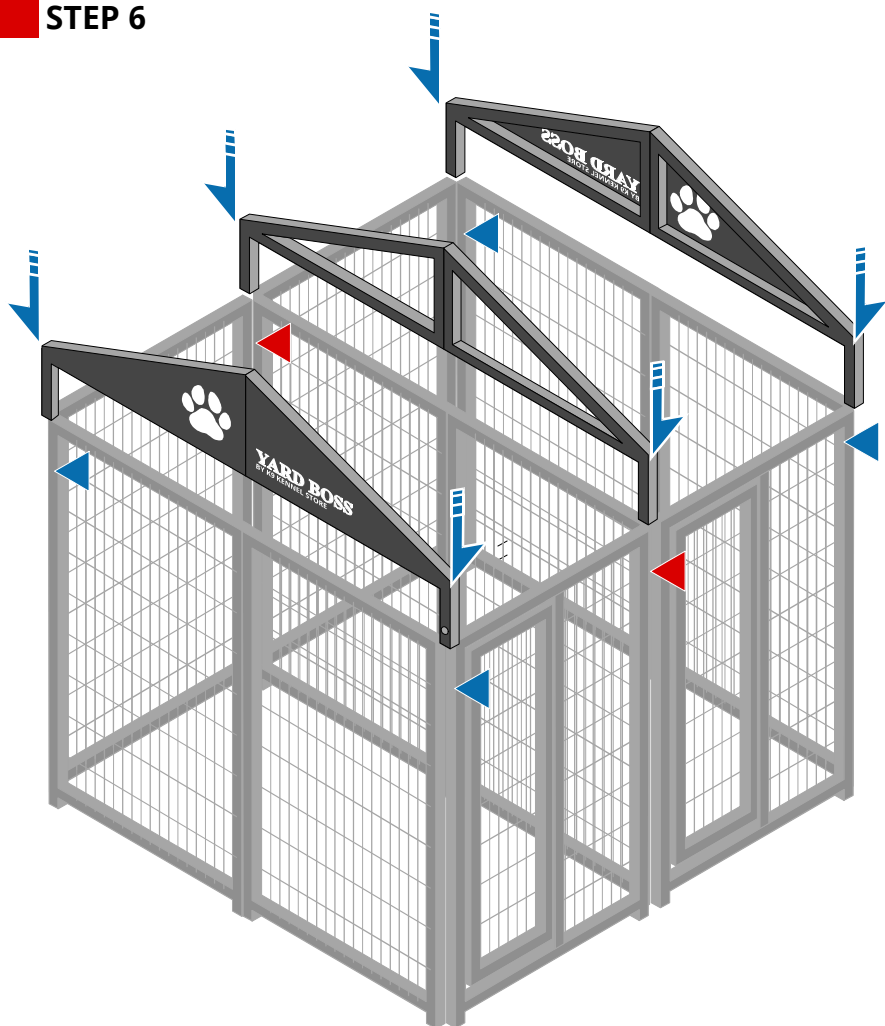

**STEP 7**

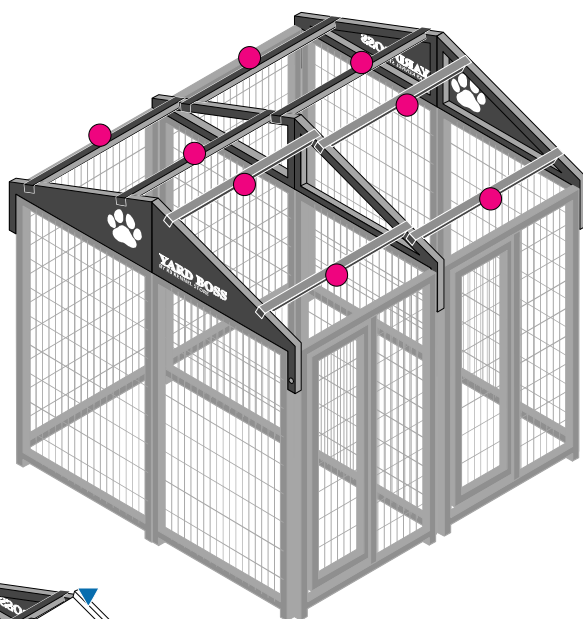
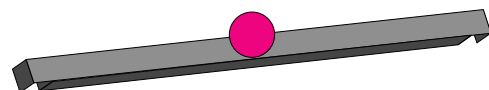

**STEP 8**

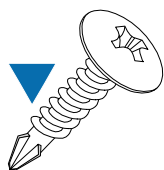
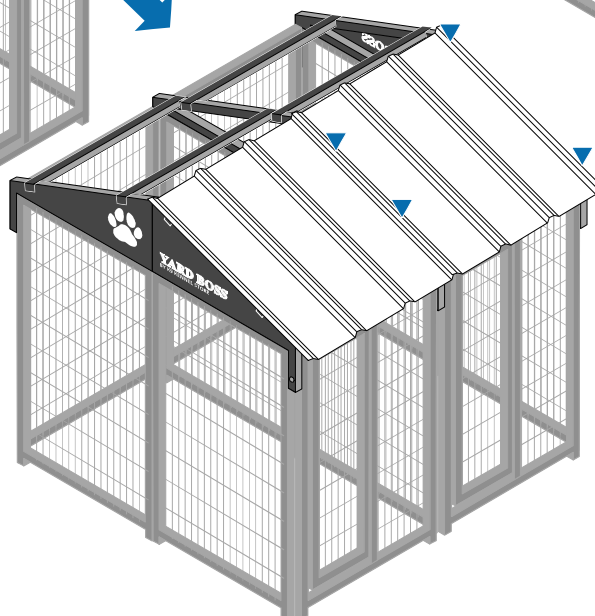
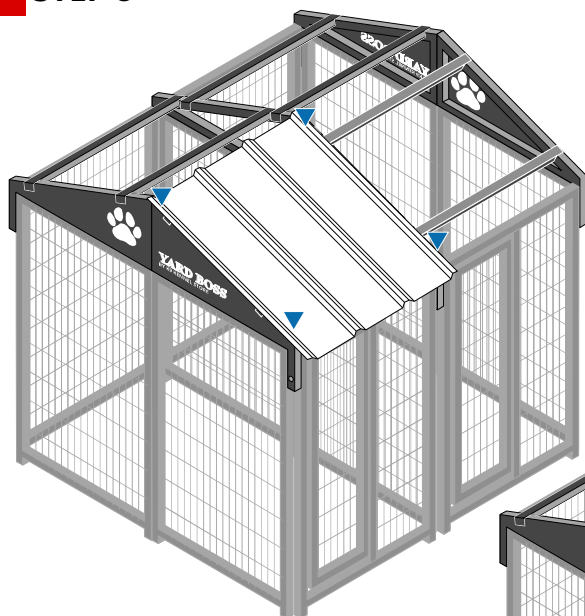

## STEP 9

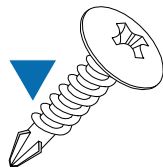
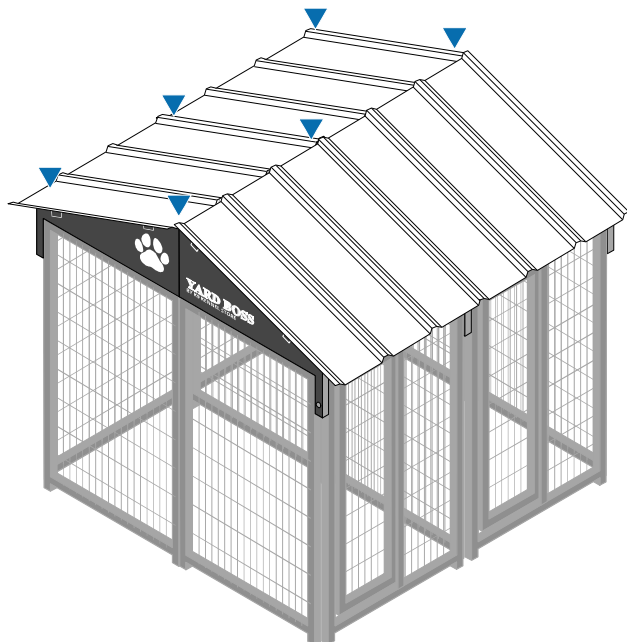

## IMPORTANT NOTES

### Middle panels Connections.

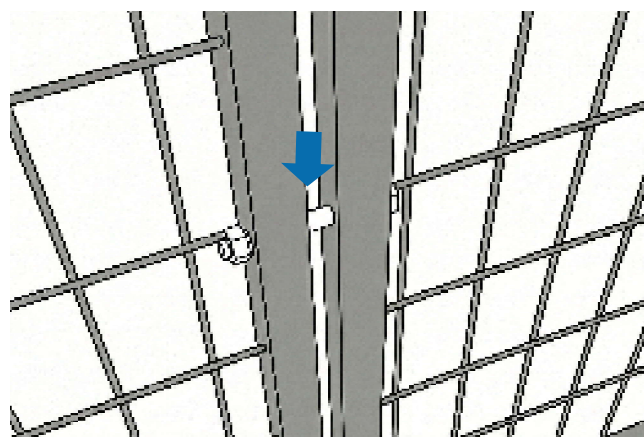
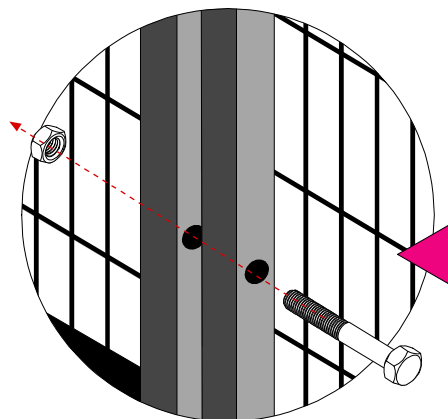
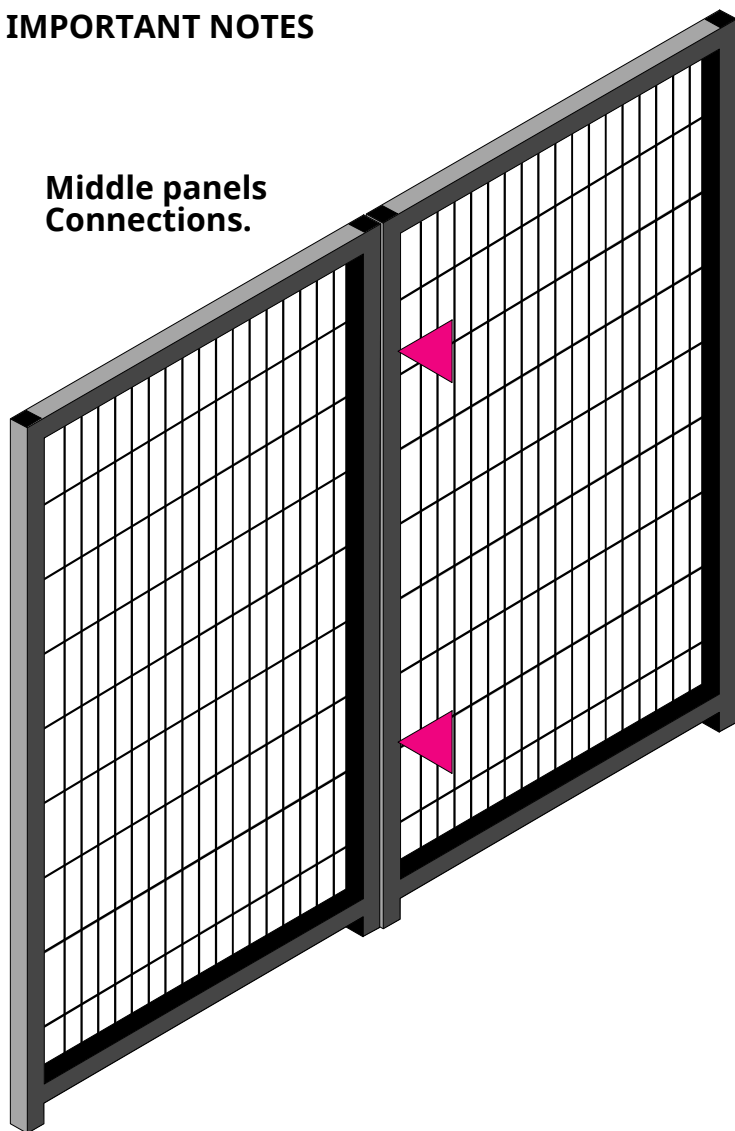

- \* There are 2 connections for each panels. Make sure you attach well.
- \* There are two kind of connections (Corner panels & Middle panels), make sure you attach the correct bolt.

**Thank You.**  
WWW.K9-KENNELSTORE.COM